

CADPIPE 2000

P&ID Tutorial



The Way Work Gets Done



CADPIPE P&ID

© 1999 Orange Technologies, Inc.
All Rights Reserved

This publication, or parts thereof, may not be reproduced in any form, by any method, for any purpose.

Orange Technologies, Inc., makes no warranty, either expressed or implied, including but not limited to any implied warranties of merchantability or fitness for a particular purpose, regarding these materials and makes such materials available solely on an "as-is" basis.

In no event shall Orange Technologies, Inc., be liable to anyone for special, collateral, incidental, or consequential damages in connection with or arising out of purchase or use of these materials. The sole and exclusive liability to Orange Technologies, Inc., regardless of the form of action, shall not exceed the purchase price of the materials described herein.

Orange Technologies, Inc., reserves the right to revise and improve its products as it sees fit. This publication describes the state of this product at the time of its publication, and may not reflect the product at all times in the future.

CADPIPE uses AutoCAD ® as the graphics driver.

CADPIPE is a registered trademark of AEC Design Group, a wholly-owned subsidiary of Orange Technologies, Inc. Autodesk, the Autodesk logo, and AutoCAD are registered trademarks, and ObjectARX, the Built with ObjectARX logo, and Design Your World are trademarks, of Autodesk, Inc., in the United States and/or other countries. All other brand names, product names, or trademarks belong to their respective holders.

Printed in the United States

P&ID Version 6.1 Tutorial.....	5
Introduction.....	5
Command Access	5
Responding to Prompts.....	5
Picking Points on the Drawing.....	5
Angle of Rotation.....	6
Correcting Errors.....	6
Help	6
Getting Started	7
Running the CADPIPE Demonstration Version	7
Create a New Drawing	7
Initialize the Drawing	8
Define Design Specifications	11
Line Designation	11
Pipe Size.....	11
Spec Check.....	12
Place Equipment	14
Vessel	14
Continuation Arrow.....	15
Draw the Main Flow Line	17
Place Valves and Fittings	18
Gate Valve	18
Check Valve.....	20
Gate Valve	21
General Control Valve with Actuator.....	22
Concentric Reducer.....	24
Concentric Reducer.....	25
Gate Valve	26
Insulation.....	26
Flanged Orifice Flowrate Symbol.....	27
Draw the Bypass	28
Move Insulation	28
Edit Line Designation	28
Draw the Bypass	29
Globe Valve	30
Change the Drawing Scale	32
Draw Signal Lines and Tap-in Line	33
Pneumatic Signal Lines.....	33
3-Way Control Valve	34
Tap-in Line	35
Gate Valves	36
Instrument Balloon	38
Electric Signal Line.....	39
Instrument Balloon	40
Drain Line.....	41
Gate Valve	42
Draw Flow line TUTOR3-ABB1.....	43
Continuation Arrow.....	44
Gate Valve	44
Draw Line TUTOR4-ABB1	45

Pair of Flanges	45
Annotate the Drawing	46
Label Flow Lines	46
Toggle Arrows	47
Title Block	48

P&ID Version 6.1 Tutorial

Introduction

This tutorial is a brief introduction to CADPIPE 2000 P&ID Version 6.1. We will show you a few key features and the general drawing procedure.

Because this is not an AutoCAD tutorial, you should have a basic working knowledge of AutoCAD before you proceed.

Command Access

You can use the CADPIPE commands through the pull-down menus or toolbars with your mouse. Please see Appendix F in the P&ID manual for a map of the pull-down menus.

Responding to Prompts

All text that appears as prompts on the computer screen is set apart from the explanatory body copy: we use a different type style.

The appropriate response to a prompt is in bold.

Prompt: **RESPONSE** <Return>

Picking Points on the Drawing

When you are required to pick a point on the drawing, we indicate the point in the text by <P1>, <P2>, etc., then show the corresponding point in an illustration. For example:

Rotation angle: **0** <Return>

Digitize location: <P1>

Text <>: **P-100** <Return>

(Pick <P1> in Figure 2)

For accuracy, place fittings with the aid of OSNAP OVERRIDES. With a two-button mouse, you can hold down the <Shift> key on the keyboard while depressing the right-hand mouse button. This will call up the OSNAPS menu.

Angle of Rotation

For angle of rotation, your system must be set to the AutoCAD defaults:

East 3 o'clock = 0°
North 12 o'clock = 90°
West 9 o'clock = 180°
South 6 o'clock = 270°

Correcting Errors

If at any time during your drawing session you are using a CADPIPE command and make a mistake, use the CADPIPE “Undoback” command to undo the drawing back to the beginning of that CADPIPE command. Pick “Undoback” from the “EDIT” menu or click the  icon.

Help

If at any time during your drawing session you need assistance understanding the program, simply press <F1> while highlighting anything on the pull-down menus. An explanation will appear, along with guides toward further help.

Getting Started

Running the CADPIPE Demonstration Version

If you are evaluating the CADPIPE programs and are running CADPIPE without hardware locks, you will be restricted in your choice of sizes, ratings, valve types, fittings, flange types, and commands. Despite these limitations, you will enjoy the power and ease of CADPIPE P&ID Version 6.0.

- Place the CADPIPE CD into the CD-ROM drive.
- Follow the prompts.

Create a New Drawing

- Select “Start” — “Programs” — “CADPIPE P&ID 6.0”
- In Project Manager, click “Create Dwg.”
- Type PIDTUTOR as the drawing name. Click “OK.”
- Highlight PIDTUTOR in the “P&ID Drawings” Window. Click “Launch PID...”

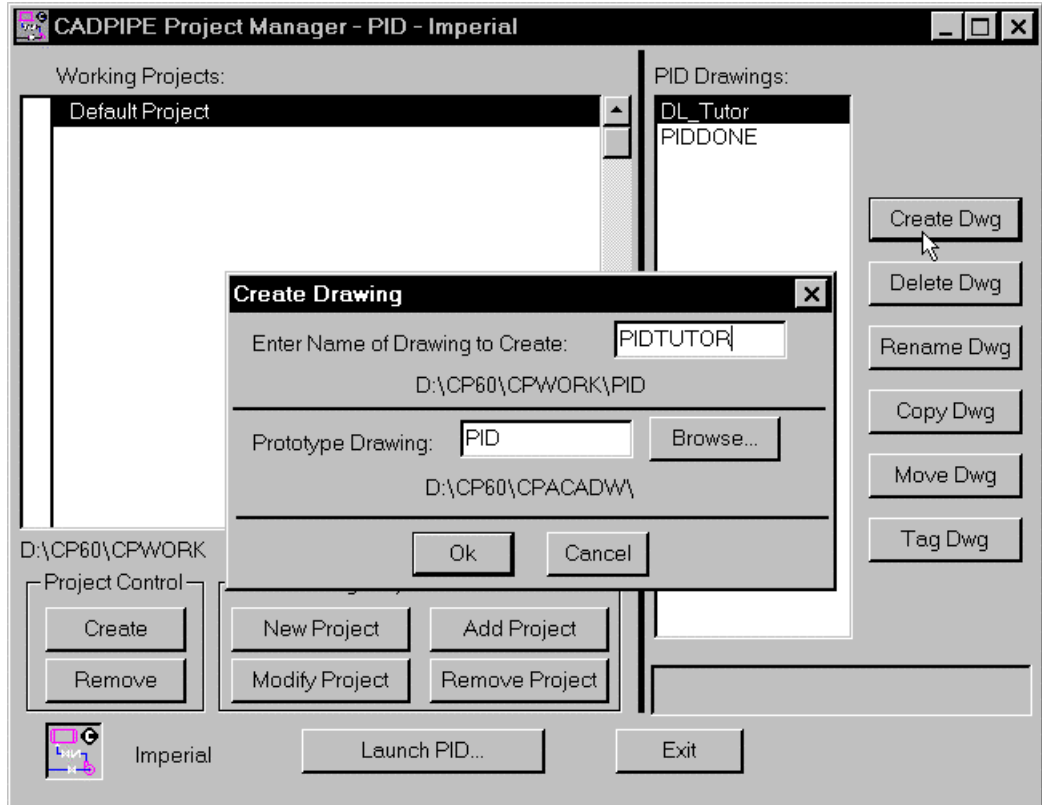

Initialize the Drawing

After the program loads, you must “initialize” the drawing: This process establishes some settings for the “prototype” or “base” drawing.

```
Ready to initialize drawing [Yes/No] <Yes>: <Return>
Do you want a border [Yes/No] <Yes>: <Return>
Select your drawing sheet size: (Select horizontal size "D-
24x36" [A1 metric] from the
dialog box.)
```

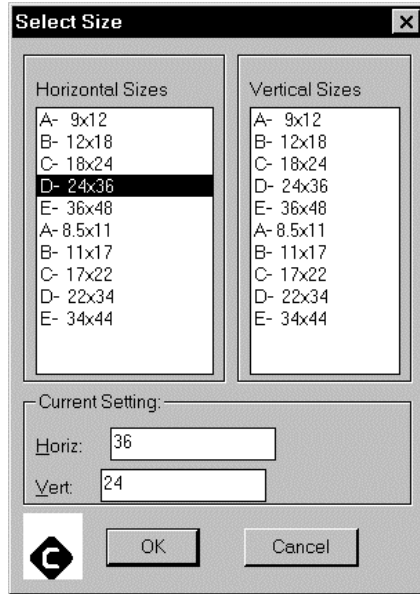
A 1.000" margin will be left outside the border:

Enter User ID: *(Enter your initials; initialization will not continue until an I.D. is entered. The I.D. is stored with the date/time stamp.)*

Job Number: **10024** <Return>

Click "OK" in the "CADPIPE Version" dialog box.



Following is the drawing you will create in this tutorial session. The drawing file is stored in the \PID (\CPDEMO in Demonstration version) directory and is called PIDDONE.DWG (MPIDDONE.DWG). The file is also stored in an executable, PIDTUT.EXE (MPIDTUT.EXE) in the \UTIL\PID directory on the CADPIPE CD.

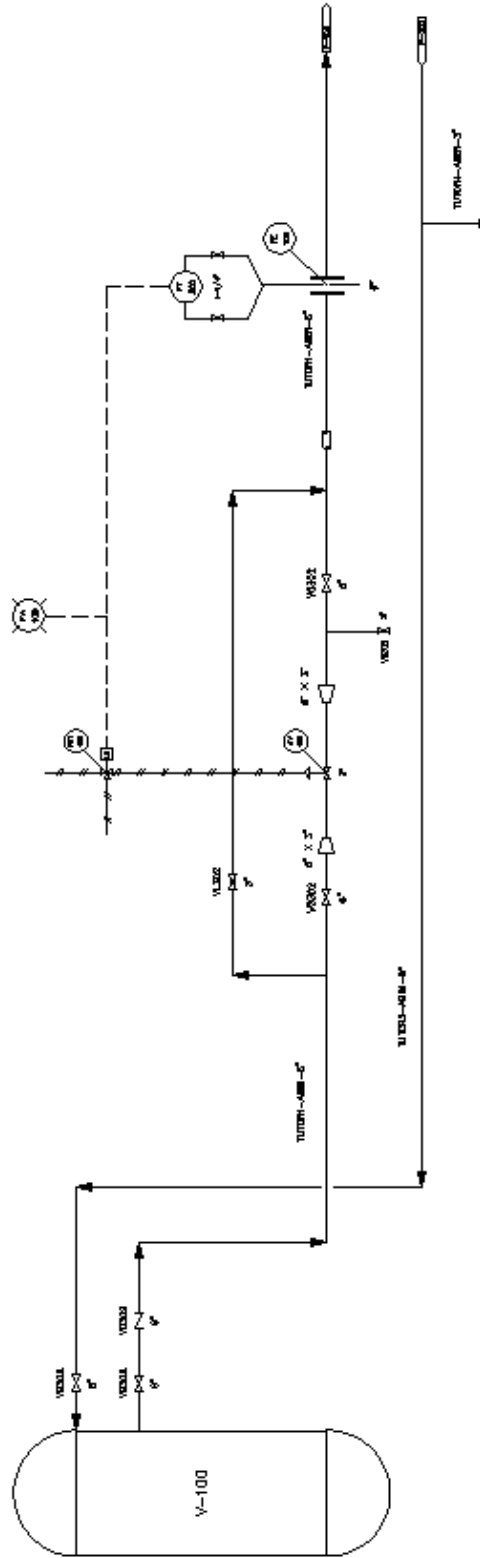

Define Design Specifications

Before drawing a flow line or placing fittings or valves, you must set the line designation and pipe size. The line designation consists of a line or equipment number and the material specification.

Line Designation

Pick "Current Settings" from the "SETTINGS" menu. In the "Line Number" field type TUTOR1.

You enter a line number when the "Pipe/Equipment" toggle is set to "Pipe." You enter an equipment number when the toggle is set to "Equipment." The Pipe/Equipment toggle sets whether valves, instrumentation and fittings are associated with the current line number (Pipe) or current equipment number (Equipment). This setting determines how items are listed in the BOM.

Click ABB1 in the Spec List. ABB1 will appear in the "Material Spec" field.

ABB1 is one of the many specifications that are supplied with CADPIPE. The specifications contain predefined settings for valves, fittings, and pipe. The specification will automatically set defaults such as rating, end type, and schedule *when the Spec Check command is on.*

Pipe Size

In the "Current Settings" dialog box, click "Size."

In the "Select Size" dialog box, click 6" (150mm) and then "OK."

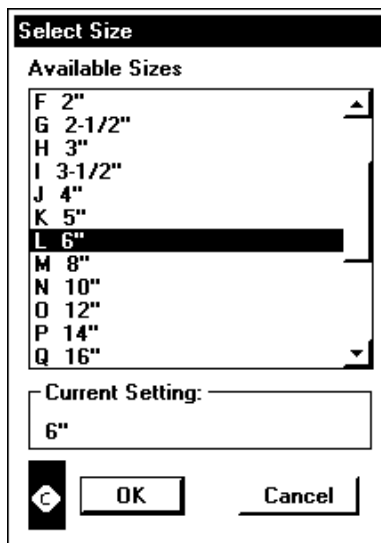

Spec Check

In CADPIPE, the designer can either access everything in the database, apply a standard specification to restrict the items that can be placed, or use a combination of both.

We will place items on the tutorial drawing with the Spec Check command on. This means that many of the defaults (end type, schedule, rating, etc.) will be set automatically by the program according to what is defined in the material specification file for specification ABB1.

In the “Current Settings” dialog box, click on the box beside “Spec Check.”

An “X” or “✓” in the box indicates that Spec Check is active.

Click “OK.”



If you exit CADPIPE before completing the tutorial drawing, remember to turn Spec Check on and reset the line designation when you reenter the drawing.

This is how the “Current Settings” box should appear when you are finished:

CADPIPE Current Settings [X]

Line Number > TUTOR1

Equipment Number > V-100

Material Spec: ABB1

Spec Check
 Spec Override

Digitize Object <

Spec List
AAA1
ABB1
C12A
C12LJ
C32A
C62A
C92A

Database...
Database : Nominal - ANSI Plus

Items Relate to:
 Pipe
 Equipment

Size... 6"
 Rating... 300#
 Ends...
Flgd-RF

Line Label Info
Insulation:
Service:
Custom:

Plant Number > Instrument Spec >
PID Number > Project Rev. Number >

 OK View Drawing...

Place Equipment

Vessel

Place a vertical pressure vessel in the upper left quadrant of the drawing, and label it V-100.

Command:

Select vertical vessel from the "PLACE" — "Equipment"—"Vessel" menu.

<BOM on>

x-dir Scale Factor <1.000>: **2** <Return> [100]

y-dir Scale Factor <2.000>: **4** <Return>

Digitize Equipment Base Point <Exit>: <P1> (Pick <P1> in illustration)

Enter angle of rotation: **0** <Return>

Enter Equipment number <>: **V-100** <Return>

Digitize Equipment Tag Location <Exit>: <P2>

Command:

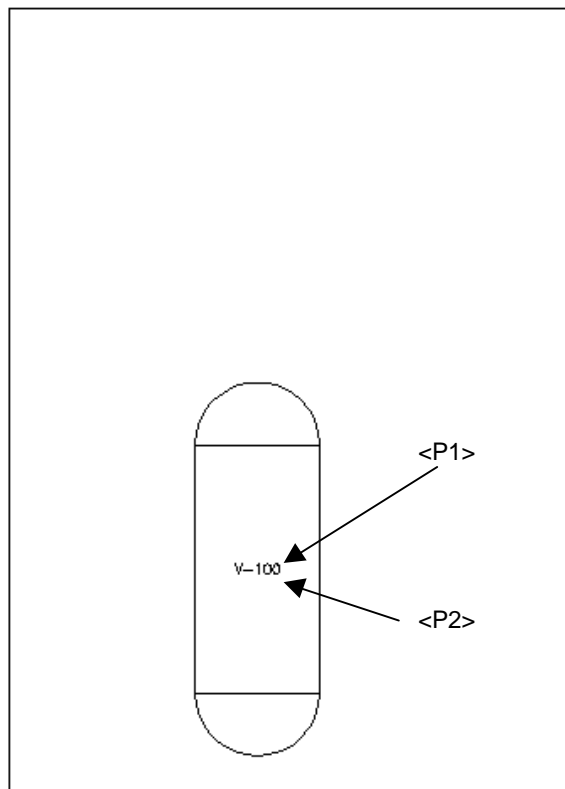

Continuation Arrow

This continuation arrow marks the end of flow line TUTOR1-ABB1 on this drawing.

Command:

Pick the continuation arrow from the “PLACE” — “General Symbols” menu, or click the  icon and pick the continuation arrow.

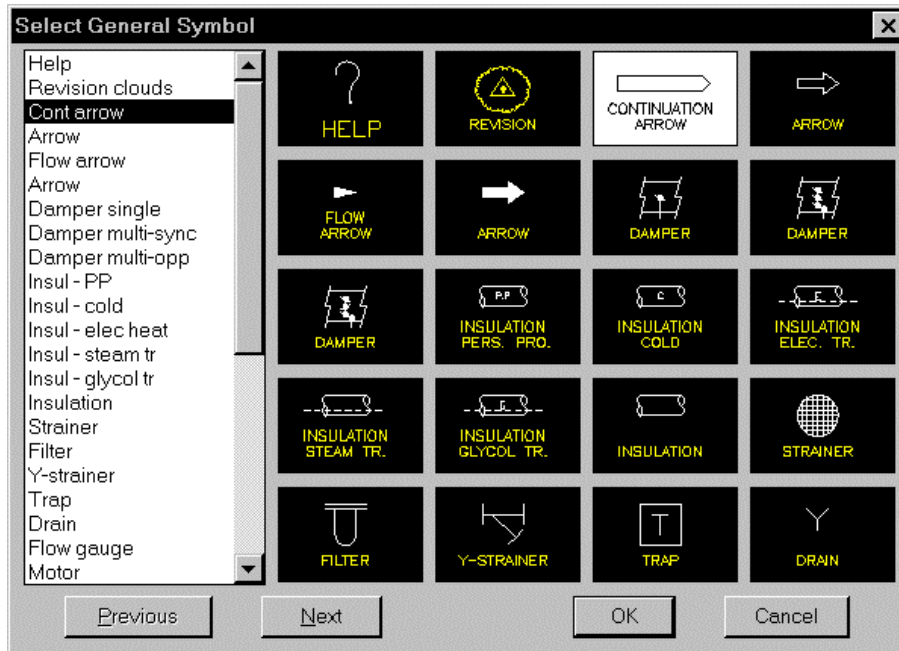

Digitize point or end of flow line <Exit>: <P1>

Enter the angle of rotation: 0 <Return>

Text: P-100 <Return>

Command:

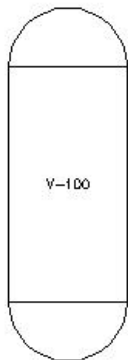

<P1>



Draw the Main Flow Line

Draw a flow line from the vessel to the continuation arrow.

CADPIPE uses an intelligent flow line. Items placed on the flow line automatically adopt the intelligence of the line. Information stored with the flow line includes: size, rating, flow line layer, whether line relates to pipe or equipment, flow direction and line designation.

Command:

Pick "Flow Line" from the "PLACE" menu, or click .

<TUTOR1 - ABB1><CPID_MFLLON>

Edit line designation/<First Point>: **<P1>** (*Digitize the first point of the flow line <P1>.*)

Next point: **<P2>**

Next point: **<P3>**

Next point: **<P4>**

Next point: **<Return>**

Command:



Place Valves and Fittings

Gate Valve

Place a gate valve on line TUTOR1 next to the vessel.

Command:

Pick the gate valve from the "PLACE" — "Valves" menu, or click  and pick the gate valve.

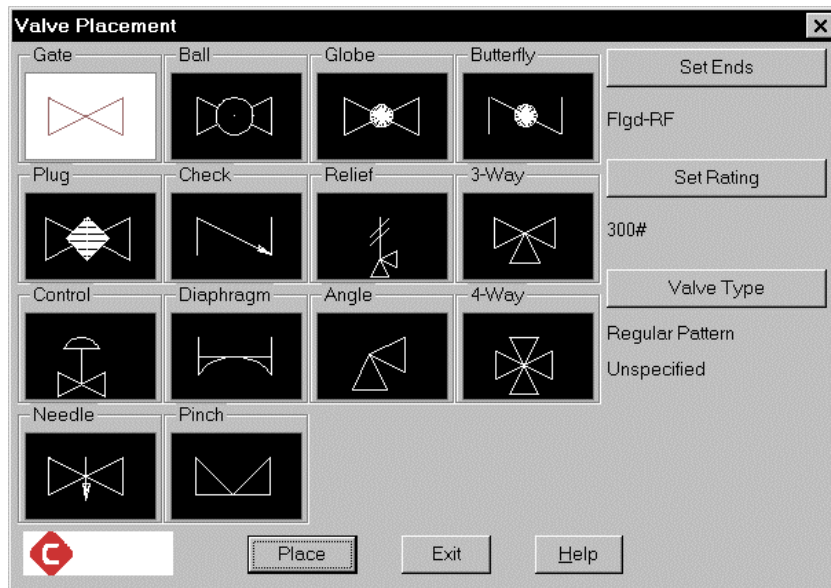

```
<BOM on><TUTOR1><Flgd-RF>  
Enter Insertion Point: <P1>  
Digitize Tag Location: <P2>  
Enter valve tag <VG302>: <Return>
```

*(Press <Return> to
accept the default tag.)*

```
Digitize Size Tag Location: <P3>  
Command:
```

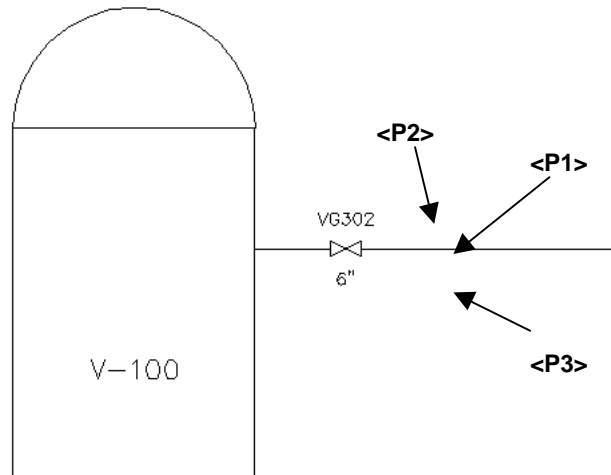

Check Valve

Place a check valve on line TUTOR1 next to the gate valve. Check valves allow flow in only one direction, so placing this check valve will designate the flow direction of line TUTOR1-ABB1.

Command:

Pick the check valve from the "PLACE" — "Valves" menu, or click  and pick the check valve.

<BOM on><TUTOR1><Flgd-RF>

Enter insertion point: <P1>

Flow direction: <P2> *(Digitize the flow direction <P2>, which will be shown by the arrows that appear on the flow line.)*

Digitize Tag Location: <P3>

Enter valve tag <VC302>: <Return>

Digitize Size Tag Location: <P4>

Command:

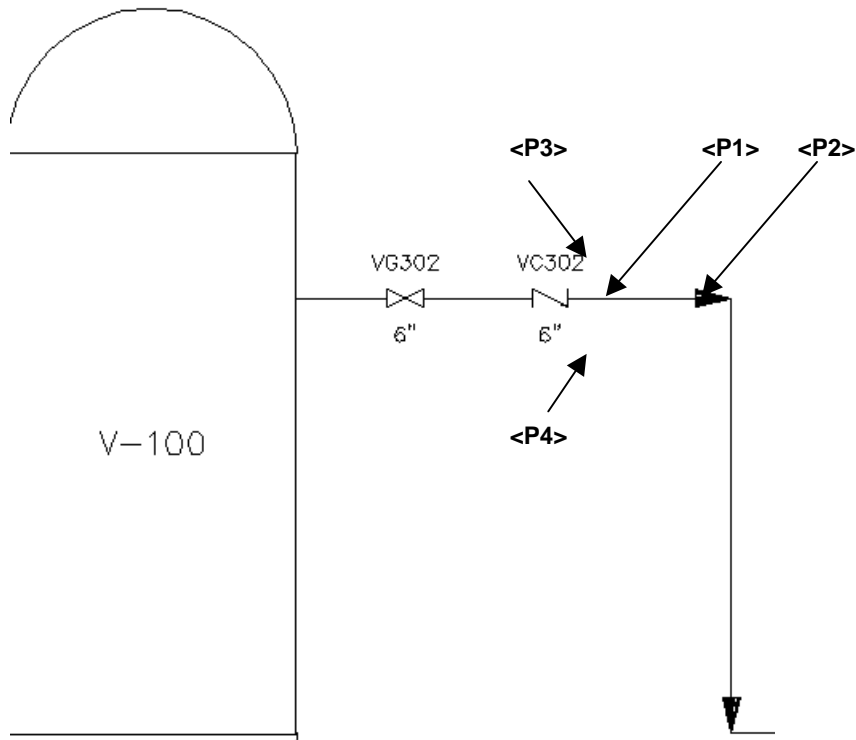

Gate Valve

Place another gate valve along the main flow line.

Command:

Pick the gate valve from the "PLACE" — "Valves" menu, or click  and pick the gate valve.

<BOM on><TUTOR1><Flgd-RF>

Enter insertion point: <P1>

Digitize Tag Location: <P2>

Enter valve tag <VG302>: <Return>

Digitize Size Tag Location: <P3>

Command:

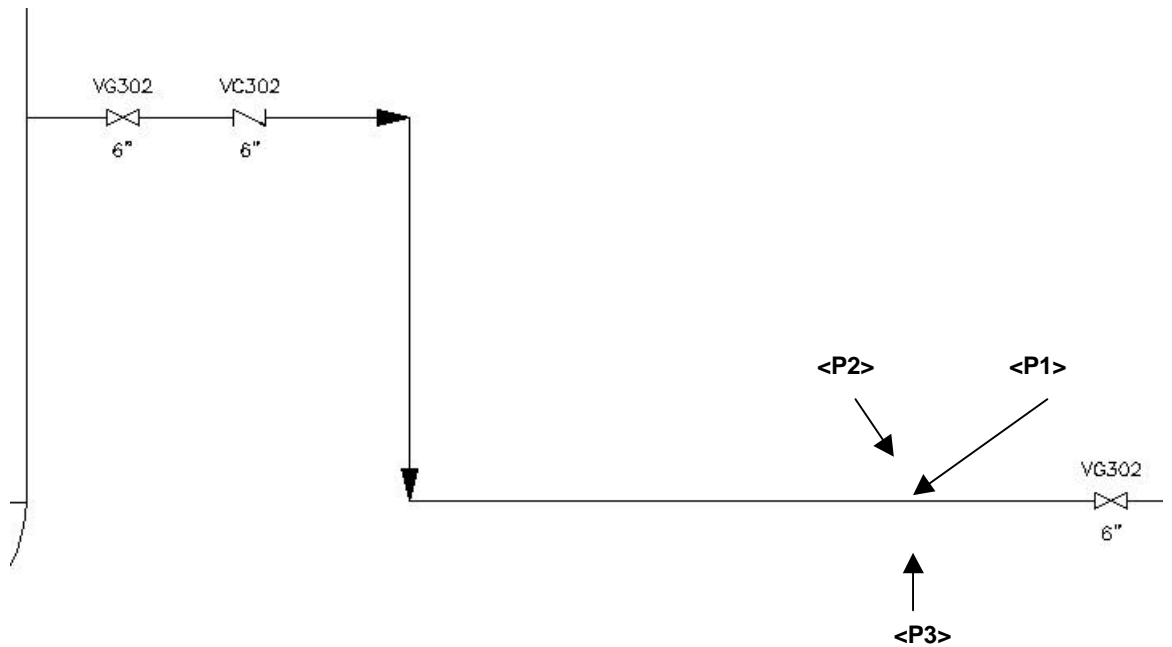

General Control Valve with Actuator

Place the 3" general control valve with an actuator next to the gate valve.

Command :

Pick the general control valve from the "PLACE" — "Control Valves" menu, or click  and pick the general control valve.

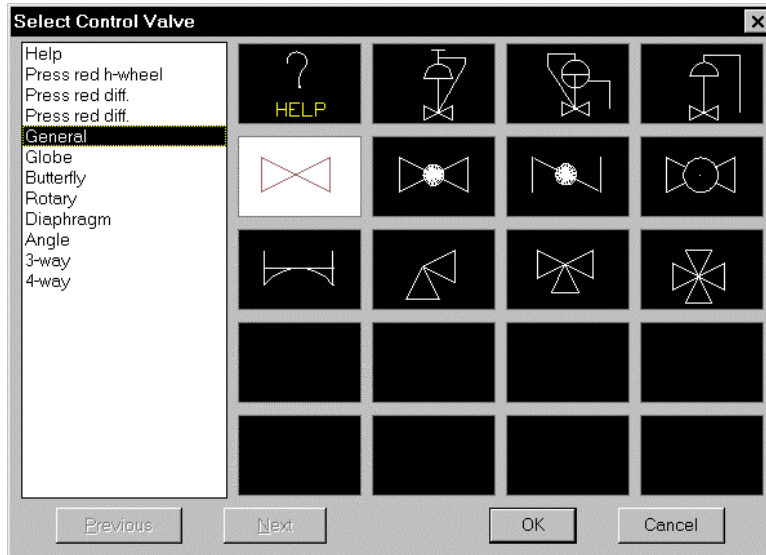

Enter insertion point: <P1>

Select Actuator:

(Select the diaphragm actuator from the menu.)

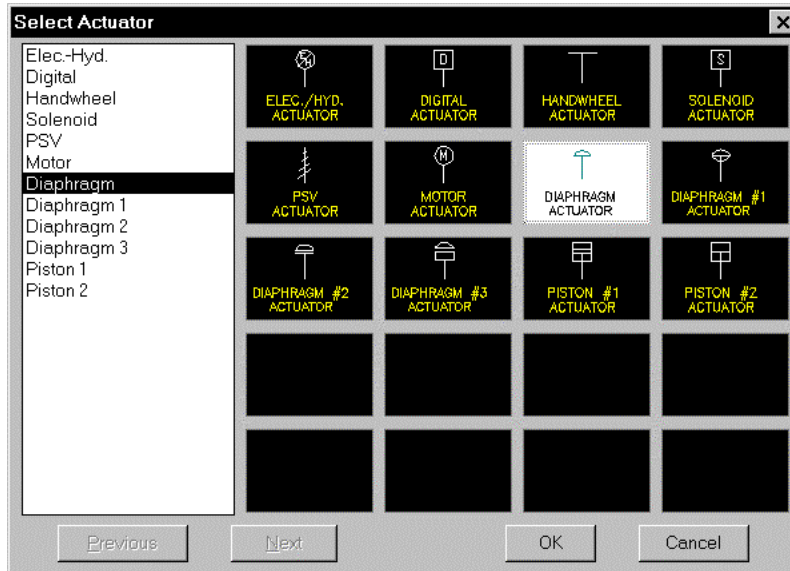

Actuator direction: <P2>
Digitize tag balloon position: <P3>

*(Label First Line "CV"
and Second Line "100".
Leave Third Line blank.
Click "OK.")*

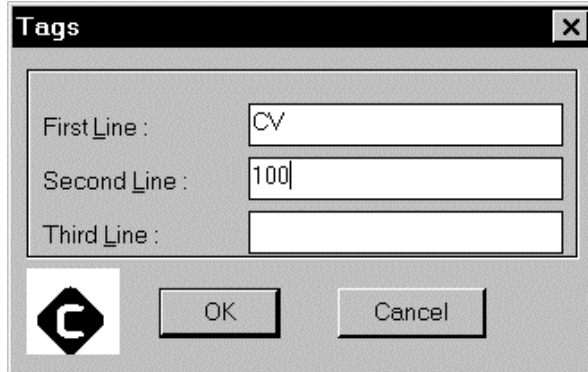

The image shows a software dialog box titled "Tags" with a close button (X) in the top right corner. It contains three text input fields: "First Line" with the text "CV", "Second Line" with the text "100", and "Third Line" which is empty. Below the input fields are three buttons: a logo button (a stylized 'C' inside a square), an "OK" button, and a "Cancel" button.

Digitize Size Tag Location: <P4>
Command:

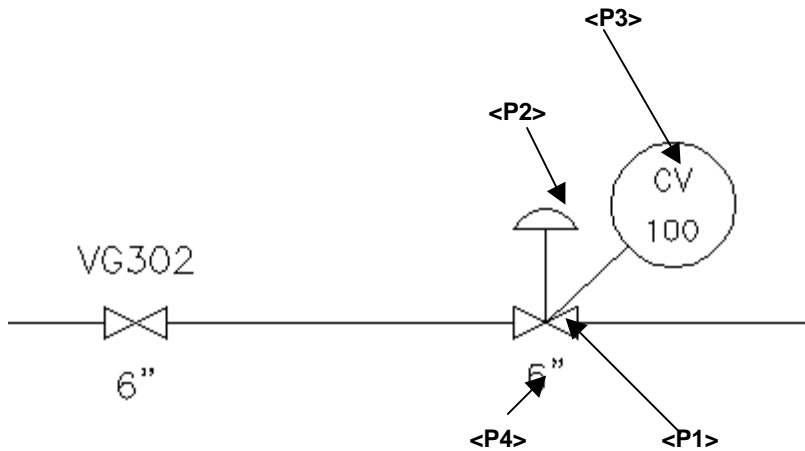

Concentric Reducer

Place a concentric reducer between the general control valve and the gate valve. The flow lines in P&ID are intelligent flow lines, so when the line size changes at the placement of this reducer, the size of anything on the line will also change, which will be indicated here by the size tag of the general control valve to the right of the reducer.

Command :

Pick the concentric reducer from the "PLACE" — "Fitting" menu, or click  and pick the concentric reducer.

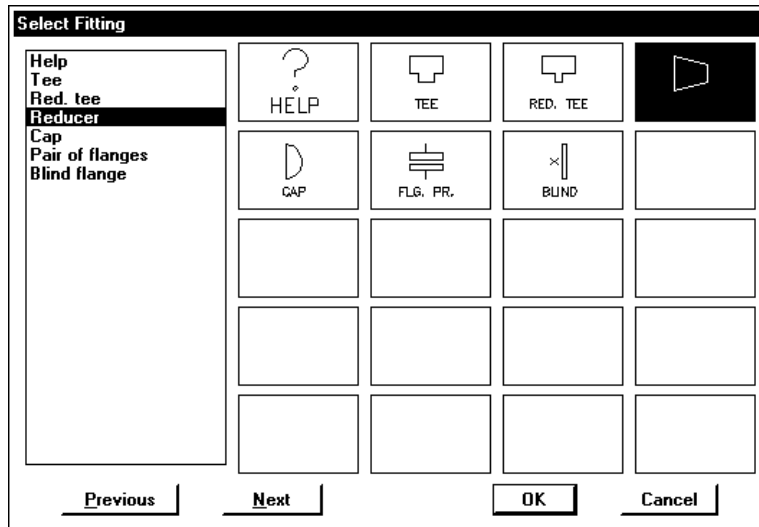

Enter insertion point: <P1>

Inlet Size (6") (Select 3" [80mm] for the outlet size from the dialog box.)

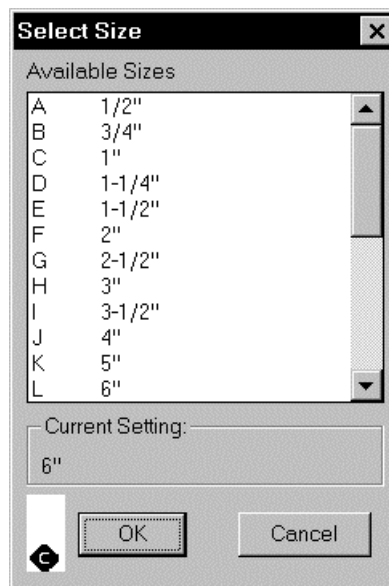

Select Outlet Direction: **<P2>**

(As the flow line changes size, the change will carry over to any item that is placed on the flow line—you will see this change reflected in the size tag of the general control valve.)

Digitize Size Tag Location: **<P3>**

Digitize line labels associated with highlighted segment **<None>**:

<Return>

(At this prompt you could digitize any line labels associated with the routing line segment that has been highlighted. We have no line labels, so press **<Return>**.)

Command:

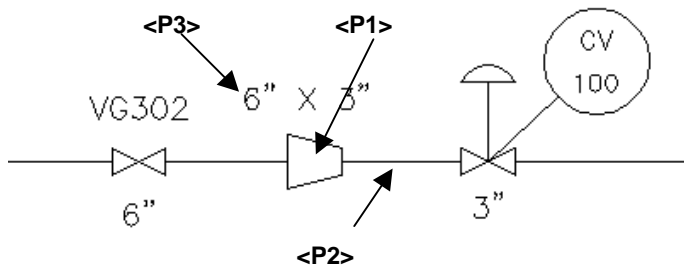

Concentric Reducer

Place another concentric reducer on the other side of the control valve.

Command:

Pick the concentric reducer from the “PLACE” — “Fitting” menu, or click  and pick the concentric reducer.

Enter insertion point: **<P1>**

(Select 6" [150mm] for the outlet size.)

Current Line Size **<6">**

Digitized Line Size **<3">**

Update size to **<3">**[Yes/No]**<Yes>**: **Return**

Select Outlet Direction: **<P2>**

Digitize Size Tag Location: **<P3>**

Digitize line labels associated with highlighted segment: **<Return>**

Command:

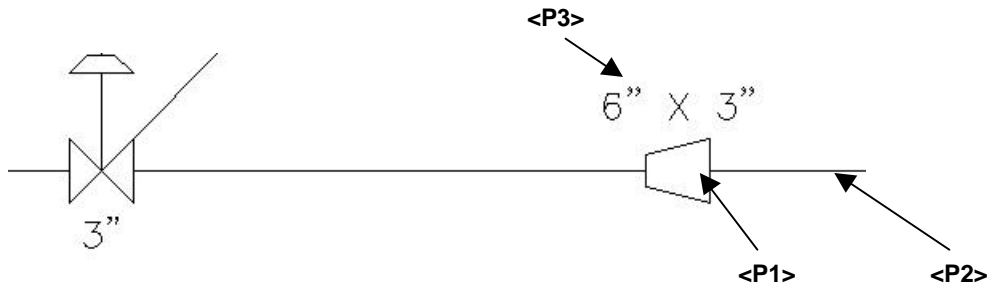

Gate Valve

Place another gate valve next to the second reducer.

Command:

Pick the gate valve from the "PLACE" — "Valves" menu, or click  and pick the gate valve.

<BOM on><TUTOR1><Flgd-RF>

Enter insertion point: <P1>

Current Line Size <3">

Digitized Line Size <6">

Update Line Size to <6"> [Yes/No] <Yes>: <Return>

Digitize Tag Location: <P2>

Enter valve tag <VG302>: <Return>

Digitize Size Tag Location: <P3>

Command:

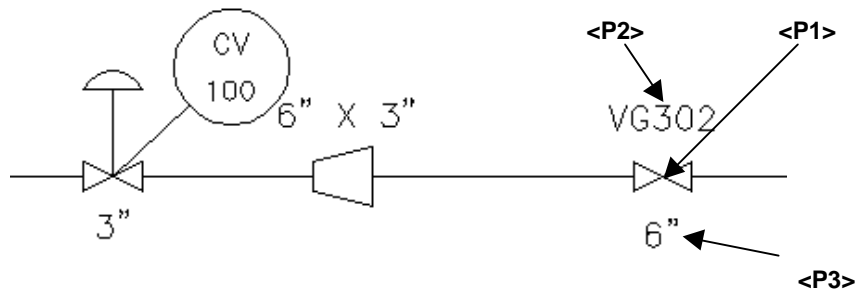

Insulation

Place an insulation symbol next to the gate valve.

Command:

Pick the insulation from the "PLACE" — "General Symbols" menu, or click  and pick the insulation.

Enter insertion point: <P1>

Command:

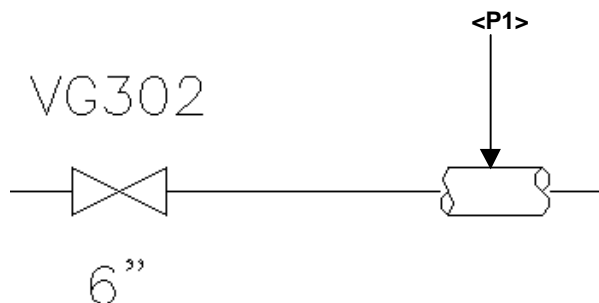

Flanged Orifice Flowrate Symbol

Place the flanged orifice flowrate symbol next to the insulation.

Command:

Pick the flanged orifice from the "PLACE" — "Flow Rate" menu.

<BOM on><TUTOR1>

Enter insertion point: <P1>

Digitize tag balloon position: <P3> (Label First Line "FE" and Second Line "100".
Leave the Third Line blank.)

Digitize Size Tag Location: <P2>

Command:

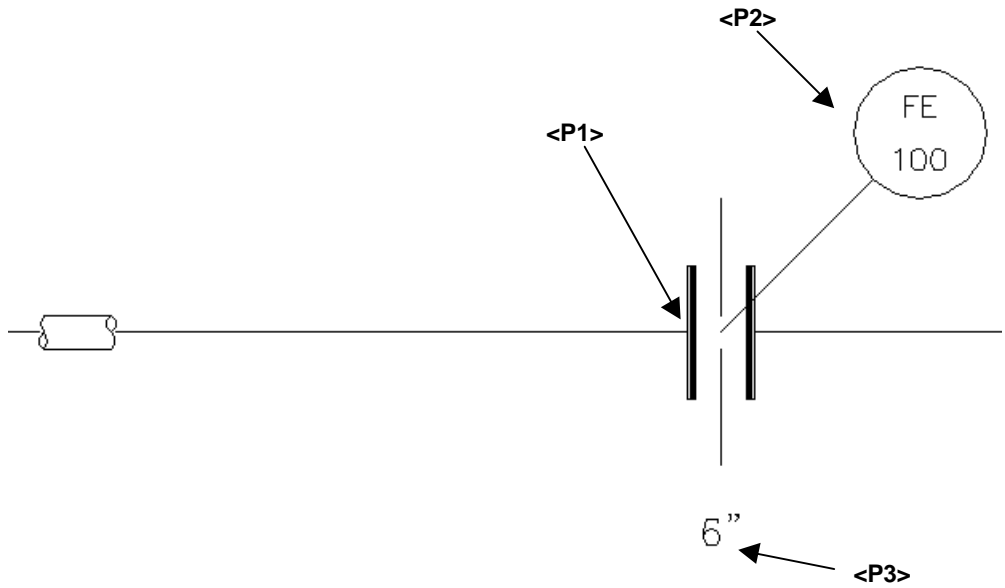

Draw the Bypass

In the “Current Settings” dialog box, change the pipe size to 3" (80mm).
Turn ORTHO and SNAP on.

Move Insulation

Before we draw the bypass line, we will move the insulation symbol to make room for where the new flow line will meet line TUTOR1-ABB1.

Command:

Click  on the drawing tool bar on the left side of your screen.

Select objects: <P1>

Select objects: <Return>

Base point of displacement: <P2>

Second point of displacement: <P3>

Command:

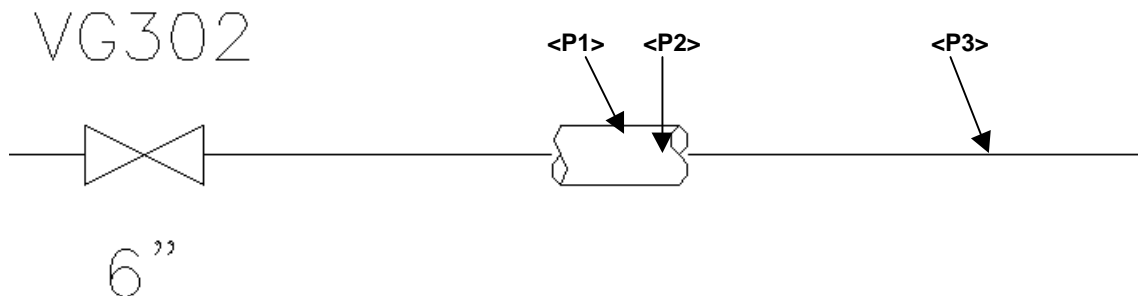

You can move valves, balloons, tags, etc., using this method. If you want to move a reducer however, you should remove the reducer using the “Edit” — “Remove” — “Remove Reducer” command, then replace it in its new position. You can move flow lines by using the “Edit” — “Flow Line” — “Move Line Segment” command. Any items that are on the flow line you are moving will move with the flow line.

Edit Line Designation

We will now set the line designation to TUTOR2-ABB1 and the layer to Secondary Flow using the designation and layer options of the Flow Line command. Then we will draw the bypass line.

Command:

Pick “Flow Line” from the “PLACE” menu or click .

<TUTOR1 - ABB1><MFLON>

Edit line designation/<First Point>: E <Return>

(Type E for the Edit Designation option. This will allow us to change the line designation to TUTOR2.)

In the Edit Line Designation box, change line number from TUTOR1 to TUTOR2. The material spec is the same as the main flow line so leave that as ABB1.

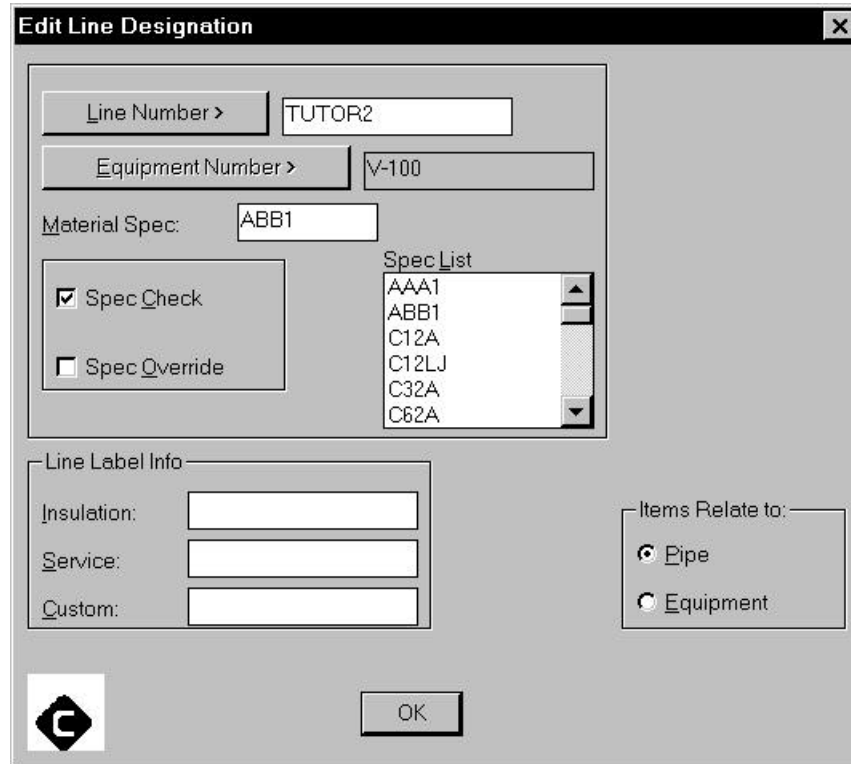

<TUTOR2 - ABB1><MFLON>

Edit Line Designation/<First Point>:

Pick "Sec. Flow" from the "PLACE" - "Flow Line Layer" menu.

(This will allow us to change the flow line layer to Secondary Flow.)

Select layer: CPid_Sfllon

Layer: CPid_Sfllon

Draw the Bypass

Command:

Pick "Flow Line" from the "PLACE" menu, or click .

<TUTOR2 - ABB1><CPid_SFLLON>

Edit line designation/<First Point>: <P1>

Next point: <P2>

Next point: <P3>

Next point: <P4>

Next point: <Return>

(The line is green to indicate that it has been placed on the Secondary Flow layer.)

Command:

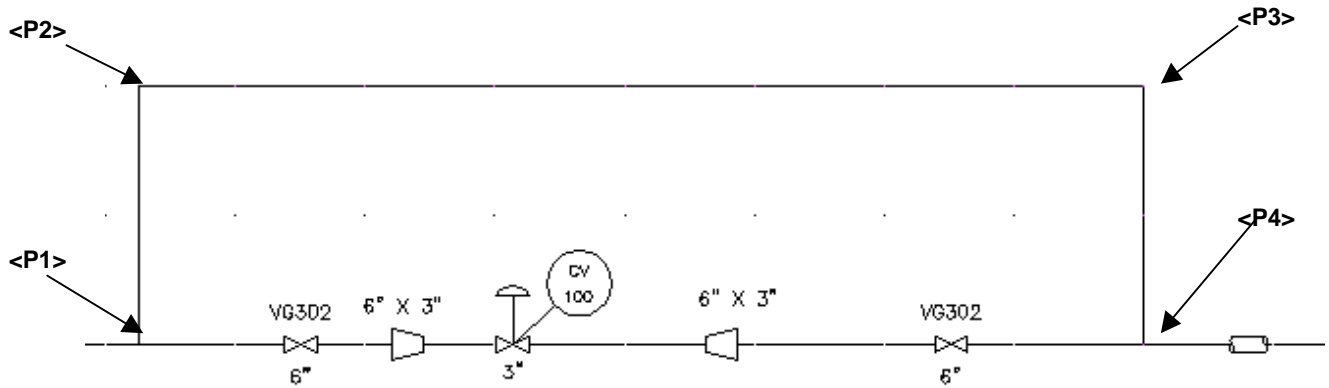

Globe Valve

Place a globe valve on the bypass.

Command:

Pick the globe valve from the "PLACE" — "Valves" menu.

<BOM on><TUTOR2><Flgd-RF>

Enter insertion point: <P1>

Digitize Tag Location: <P2>

Enter valve tag <VL302>: <Return>

Digitize Size Tag Location: <P3>

Command:

<P2>

<P1>



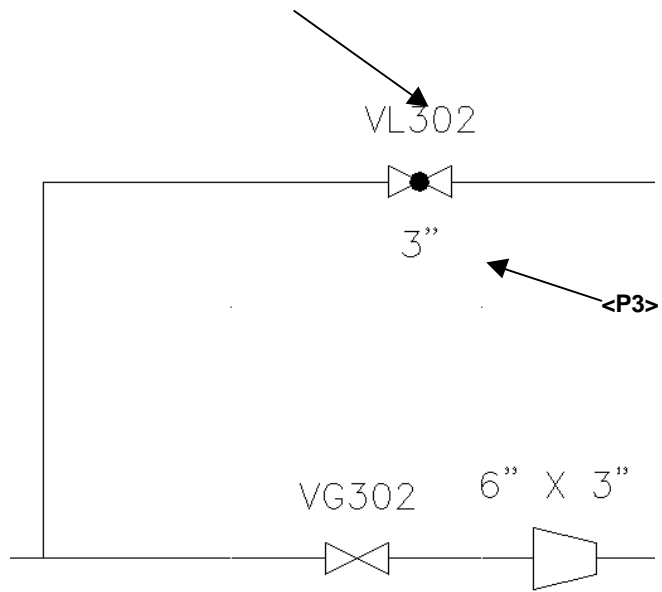

Change the Drawing Scale

To reduce the size of the next few items we place, change the drawing scale to 0.75.

Pick "System Defaults" from the "SETTINGS" pull-down menu.

Click "Drawing Scale."

Type "0.75" Click "OK."

Exit the "Systems Defaults" dialog box.

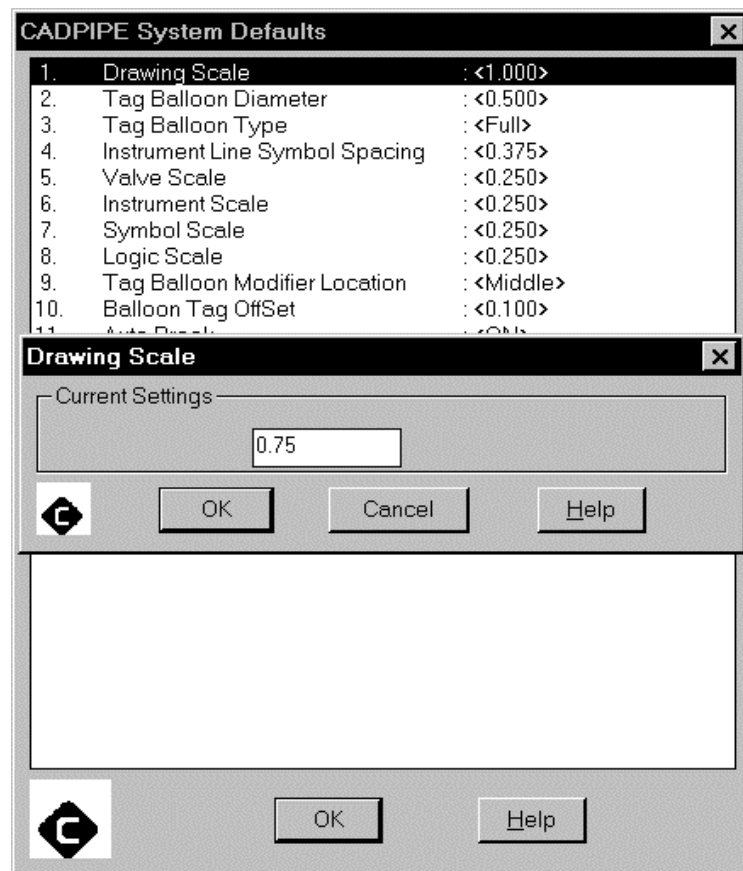

Draw Signal Lines and Tap-in Line

Pneumatic Signal Lines

First, change the pipe size to 1-1/4" (32mm) in the Current Settings dialog box.

Place the pneumatic signal line at the control valve actuator.

Command:

Pick the pneumatic signal line from the "PLACE" — "Instrument Line" menu, or click  and pick the pneumatic signal line.

First point: `_qua of <P1>` (Use OSNAP Quadrant to pick <P1>.)

Next point: `<P2>`

Next point: `<Return>`

Command: `<Return>` (This restarts the placing of the signal line.)

First point: `_endp of <P2>` (Use OSNAP ENDpoint to pick <P2>.)

Next point: `<P3>`

Next point: `<Return>`

Command: `<Return>`

First point: `_end of <P2>`

Next point: `<P4>`

Next point: `<Return>`

Command:

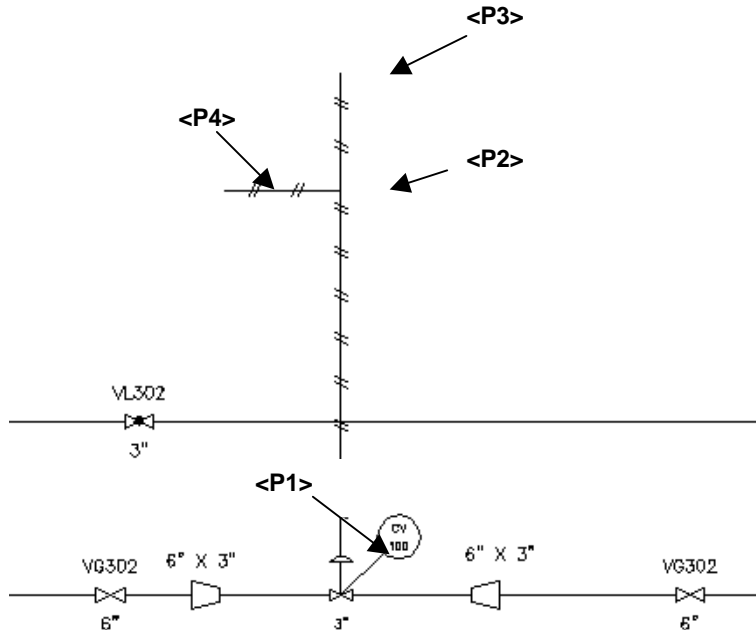

3-Way Control Valve

Place the 3-way control valve on the pneumatic signal line.

Command:

Pick the 3-way control valve from the “PLACE” — “Control Valves” menu, or click  and pick the 3-way control valve.

Enter insertion point: `_int <P1>` *(Use OSNAP INTersection to place the valve at the intersection of the instrument lines at <P1>)*

Select Actuator: *(Select the solenoid actuator from the menu.)*

Actuator Direction: `<P2> <Return>`

Digitize tag balloon position: `<P3>` *(Label the First Line “FCV” and the Second Line “100”. Leave the Third Line blank.)*

Digitize Size Tag Location: `<Return>`

(We will not place a size tag. Press <Return> for

none.)

Command:

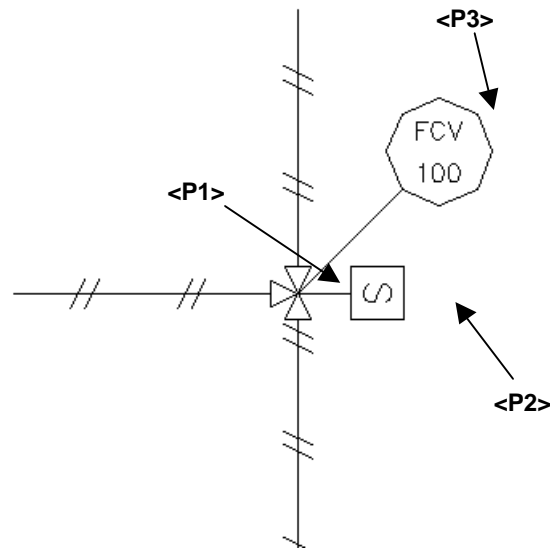

Tap-in Line

Draw the tap-in line for the flanged orifice flowrate symbol.

In the “Current Settings” dialog box, change the line number to FT. The pipe size should be 1-1/4" (32mm).

Command:

Pick “Flow Line” from the “PLACE” menu, or click .

<FT - ABB1><CPid_SFULLON>

Edit Line Designation/<First Point>: **_endp of <P1>**

(Use OSNAP ENDpoint to pick <P1>.)

Next point: **<P2>**

*(The next pick may be easier with ORTHO off.)
(Turn ORTHO back on.)*

Next point: **<Ortho off> <P3>**

Next point: **<Ortho on> <P4>**

Next point: **<P5>**

Next point: **<P6>**

Next point: **<P7>**

Next point: **<Return>**

Command:

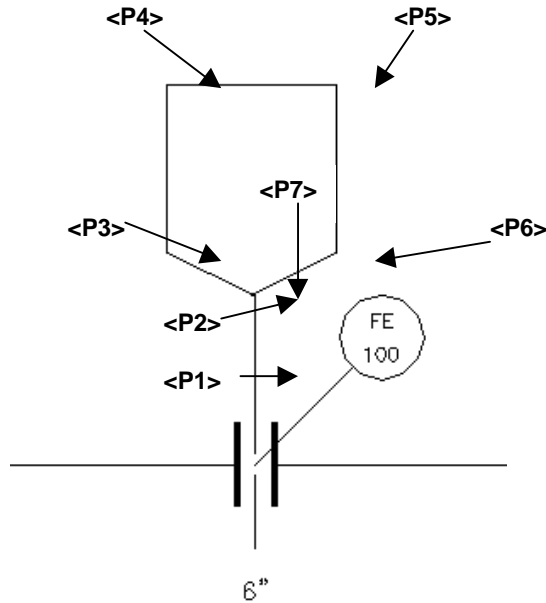

Gate Valves

Place two 1-1/4" (32mm) gate valves on the tap-in line.

First, activate Spec Override. The ABB1 spec will not allow you to place a gate valve on any pipe that is 2" or smaller, so we will override the spec for this step.

In the "Current Settings" box, click on "Spec Override." An "X" or "✓" in the box indicates that Spec Override is active. Click "OK."

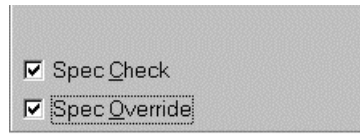

Command:

Pick the gate valve from the "PLACE" — "Valves" menu or click  and pick the gate valve.

<BOM on><FT><Flgd-RF>

Enter insertion point: <P1>

Digitize tag location: <Return> (Do not place a tag with this valve.)

Digitize size tag location: <P2>

Command:

Spec Override is only active for one set of placement commands, so you will need to turn it back on to place the second gate valve. In the "Current Settings" box, click on "Spec Override," then click "OK."

Pick the gate valve from the "PLACE"—"Valves" menu, or click  and pick the gate valve.

Enter insertion point: <P3>

Digitize tag location: <Return>

Digitize size tag location: <Return>

(We placed the size tag with the previous valve. Press <Return> for none.)

Command:

<P2>

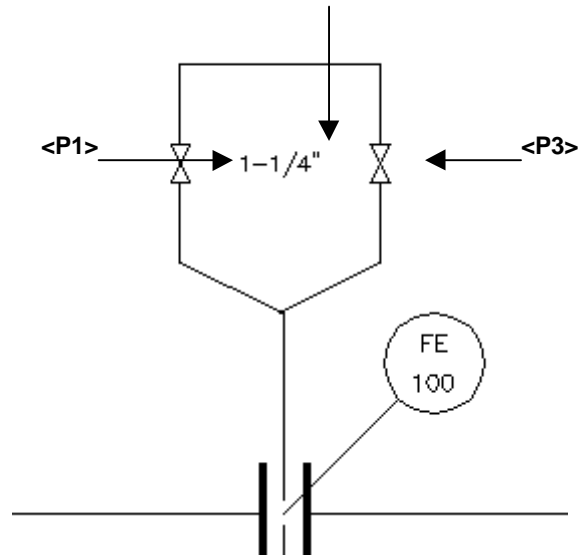

Instrument Balloon

First, change the drawing scale to “1.00” with the “Settings” — “System Defaults” command.

Place the instrument balloon on the tap-in line.

Command:

Pick balloon in-line from the “PLACE” — “Instrument Balloon” menu, or click  and pick the balloon in-line.

<BOM On><FT><1-1/4"><800#>

Enter insertion point: <P1>

(Label the First Line “FT” and the Second Line “200”. Leave the Third Line blank. Click “OK.”)

Command:

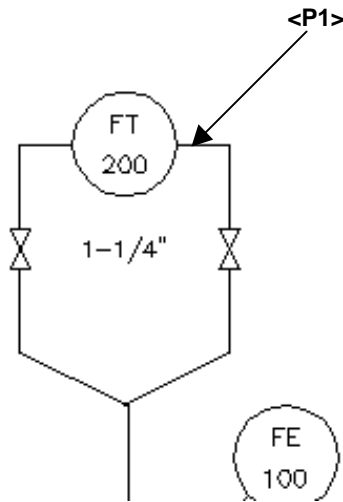

Electric Signal Line

Draw the electric instrument signal line from FT-200 to the solenoid actuator on FCV-200.

Command:

Pick the dashed electric signal line from the “PLACE” — “Instrument Line” menu, or click  and pick the dashed electric signal line.

First point: `_nod of <P1>`

(Use OSNAP Node to pick <P1>.)

Next point: `<P2>`

Next point: `<snap off> _mid of <P3>`

(Use OSNAP MIDpoint to pick <P3>. It may be easier with SNAP off.)

Next point: `<Return>`

Command:

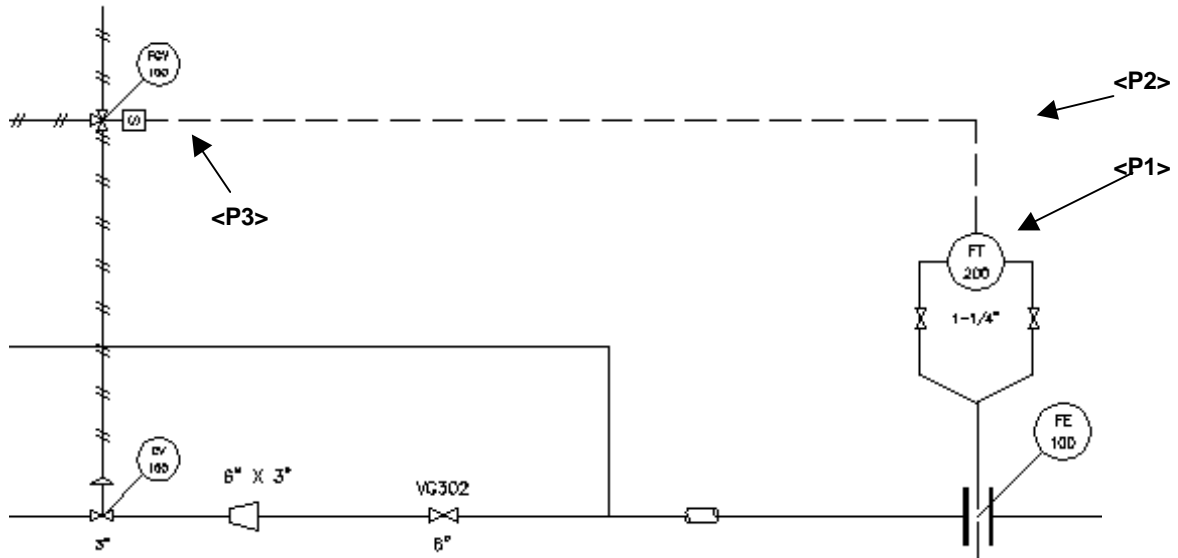

Instrument Balloon

Place the instrument balloon labeled FA-100 off the electric instrument signal line, modify the balloon with the pilot light, and draw the electric signal line from the balloon to the other signal line.

Command:

Pick the balloon from the "PLACE" — "Instrument Balloon" menu, or click  and pick the balloon.

<BOM on><FT><1-1/4"><800#>

Enter insertion point: <P1> (Label the First Line "FA" and the Second Line "100".
Leave the Third Line blank.)

Command:

Pick the pilot light from the "PLACE" — "Instrument Modifier" menu, or click  and pick the pilot light.

Digitize balloon: <P2>

Command:

Pick the dashed electric signal line from the "PLACE" — "Instrument Line" menu, or click  and pick the dashed electric signal line.

First point: nod of <P3> (Use OSNAP Node to pick <P3>.)

Next point: <P4>

Next point: <Return>

Command:

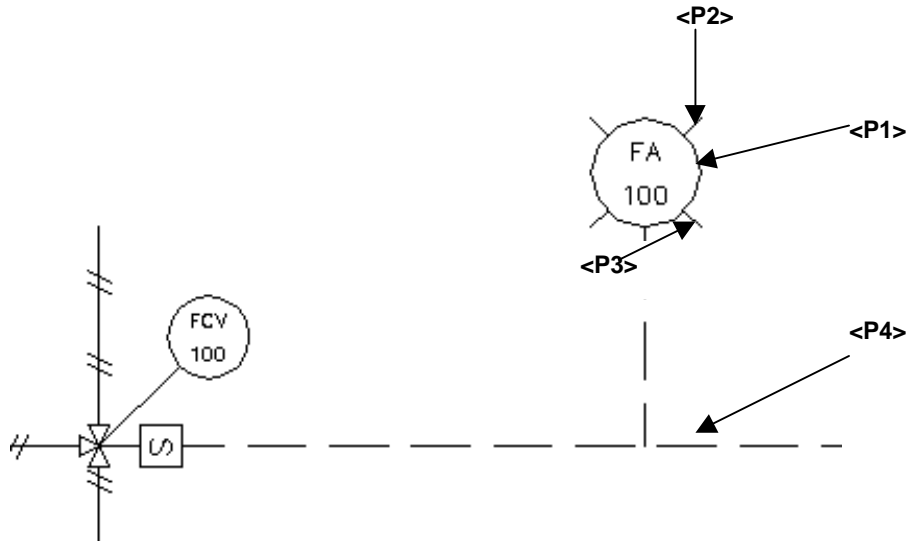

Drain Line

Draw a drain line off the flow line TUTOR1-ABB1.

In the “Current Settings” dialog box change the pipe size to 3" (80mm) and the line number to TUTOR1. The material spec remains the same.

Command:

Pick “Flow Line” from the “PLACE” menu, or click .

<TUTOR1 - ABB1><CPid_SFLON>

Edit line designation/<First Point>: <P1>

Next point: <P2>

Next point: <Return>

Command:

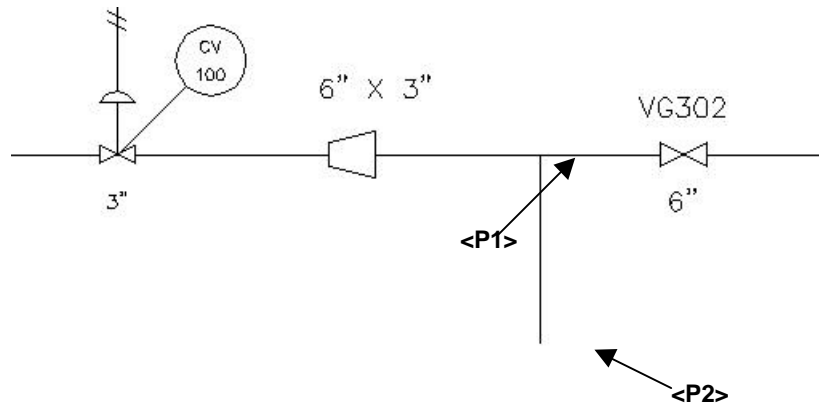

Gate Valve

First, change the drawing scale to “.75” using the “Settings” — “System Defaults” command.

Place a gate valve on the drain line.

Command:

Pick the gate valve from the “PLACE” — “Valves” menu, or click  and pick the gate valve.

<BOM on><TUTOR1><Flgd-RF>

Enter insertion point: <P1>

Digitize Tag Location: <P2>

Enter valve tag <VG302>: <Return>

Digitize Size Tag Location: <P3>

Command:

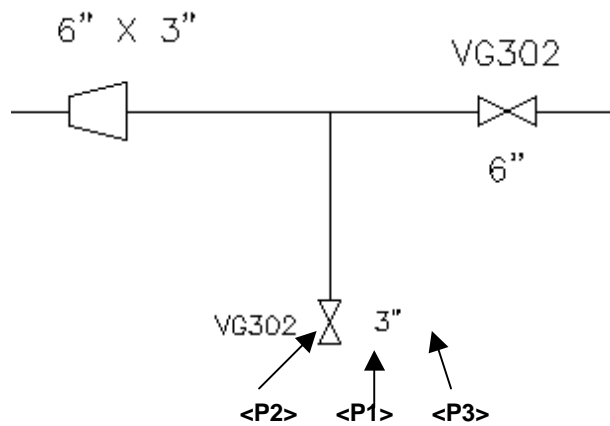

Draw Flow line TUTOR3-ABB1

Place another flow line off the vessel.

In the “Current Settings” dialog box change the pipe size to 6" (150mm) and the Line Number to TUTOR3. The material spec remains the same.

In the “System Defaults” box, change the Drawing Scale to 1.00. Click “OK.”

Command:

Pick “Flow Line” from the “PLACE” menu, or click .

<TUTOR3 - ABB1><CPid_SFULLON>

Edit line designation/<First point>: <P1>

Next point: <P2>

Next point: <P3>

Next point: <P4>

Next point: <Return>

Command:

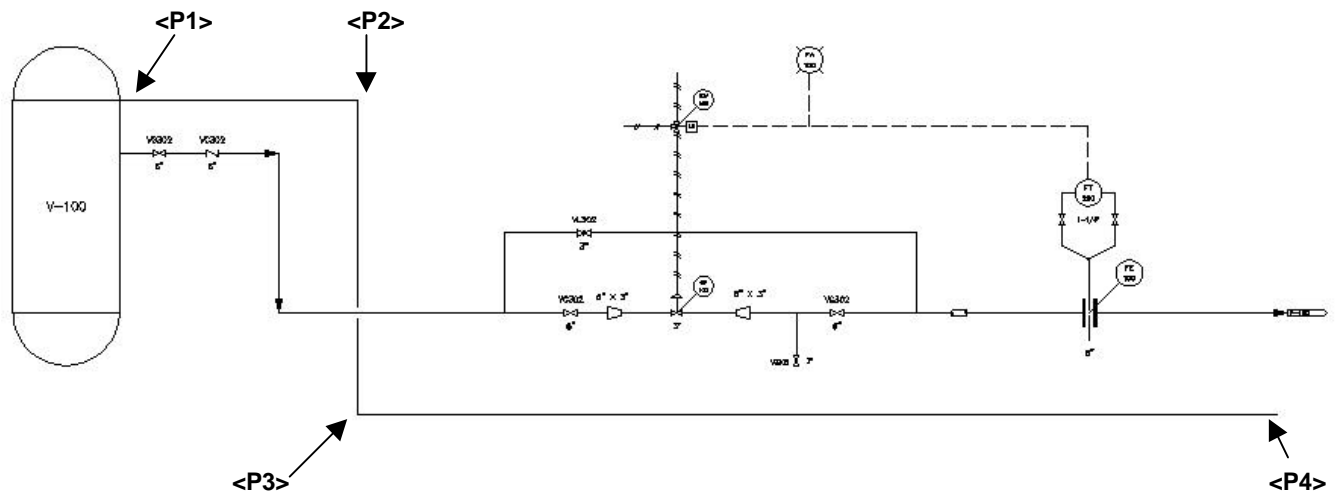

Continuation Arrow

This continuation arrow marks the end of flow line TUTOR3-ABB1 in this drawing.

Command:

Pick the continuation arrow from the "PLACE" — "General Symbols" menu, or click  and pick the continuation arrow.

Digitize point or end of flow line: <P1>

Flow Direction: <P2>

Enter Text: P-200 <Return>

Command:

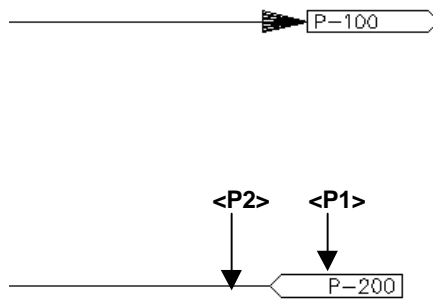

Gate Valve

Place the gate valve near the vessel on line TUTOR3.

Command:

Pick the gate valve from the "PLACE" — "Valves" menu, or click  and pick the gate valve.

<BOM on><TUTOR3><Flgd-RF>

Enter insertion point: <P1>

Digitize Tag Location: <P2>

Enter valve tag <VG302>: <Return>

Digitize Size Tag Location: <P3>

Command:

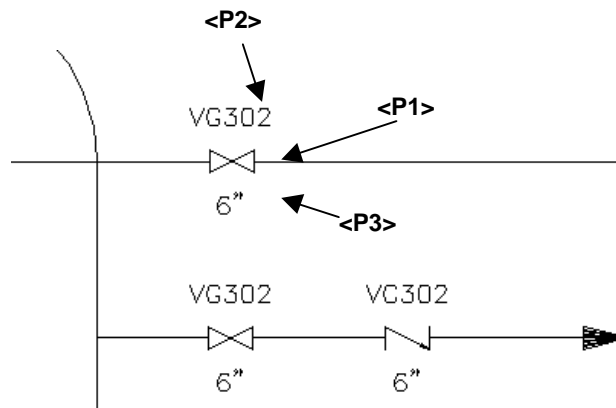

Draw Line TUTOR4-ABB1

Now, draw a drain line off line TUTOR3.

In the “Current Settings” dialog box change the pipe size to 3" (80mm) and the line number to TUTOR4. The material spec remains the same.

Command:

Pick “Flow Line” from the “PLACE” menu, or click .
<TUTOR4 - ABB1><CPid_SFLLON>
Edit line designation/<First point>: <P1>
Next point: <P2>
Next point>: <Return>
Command:

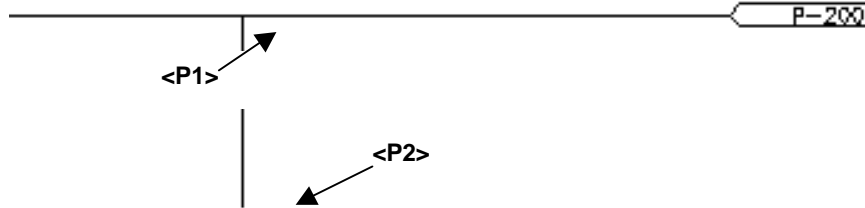

Pair of Flanges

Place a pair of flanges at the end of the drain line.

Command:

Pick the pair of flanges from the “PLACE” — “Fitting” menu, or click  and pick the pair of flanges.
Enter insertion point: <P1>



Annotate the Drawing

Label Flow Lines

We will now label all flow lines.

Set your SNAP to 1/8" (2.5).

Command: **Snap <Return>**

Snap Spacing or ON/OFF/Aspect/Rotate/Style 0'-0 1/4">: **1/8 <Return>**

Command:

Pick "Label Line" from the "ANNOTATION" menu.

Select flow line: **<P1>** (Pick a point on line TUTOR1-ABB1.)

Enter insertion point: **<P2>**

Enter angle of rotation: **0 <Return>** (Repeat the command.)

Select flow line: **<P3>** (Pick a point on line TUTOR3-ABB1.)

Enter insertion point: **<P4>**

Enter angle of rotation: **0 <Return>** (Repeat the command.)

Select flow line: **<P5>** (Place another line label on TUTOR1-ABB1.)

Enter insertion point: **<P6>**

Enter angle of rotation: **0 <Return>** (Repeat the command.)

Select flow line: **<P7>** (Pick a point on the drain line TUTOR4-ABB1.)

Enter insertion point: **<P8>**

Enter angle of rotation: **0 <Return>**

Command:

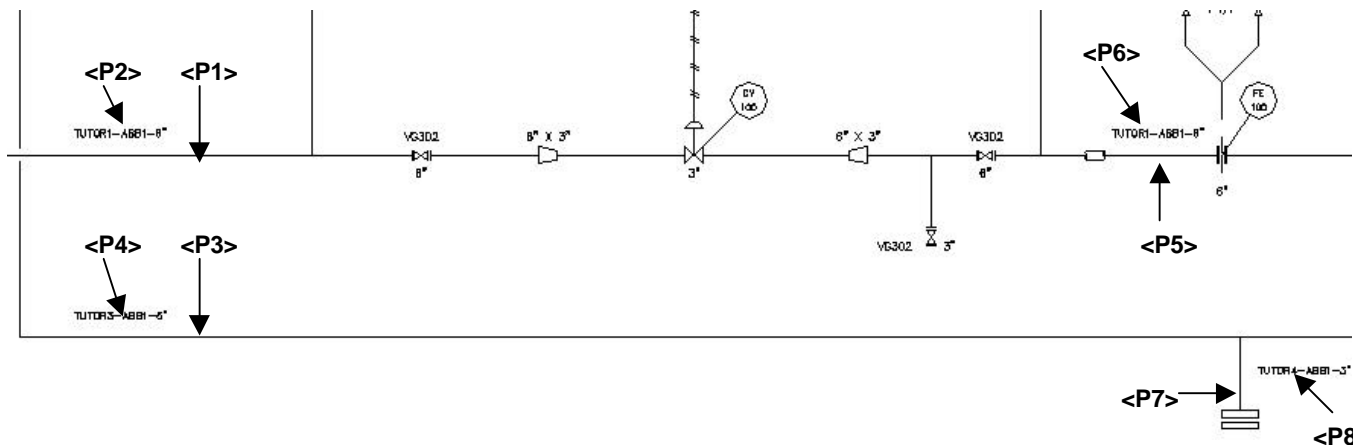

Toggle Arrows

Place arrows on the flow lines to indicate flow direction.

Command:

Pick "Toggle Arrows" from the "AUTO" menu.

Select flow line: <P1> *(We do not need to place arrows on TUTOR1 because they were placed with the check valve.)*

Direction to flow: <P2>

Repeat the command.

Select flow line: <P3>

Direction to flow: <P4>

Command:

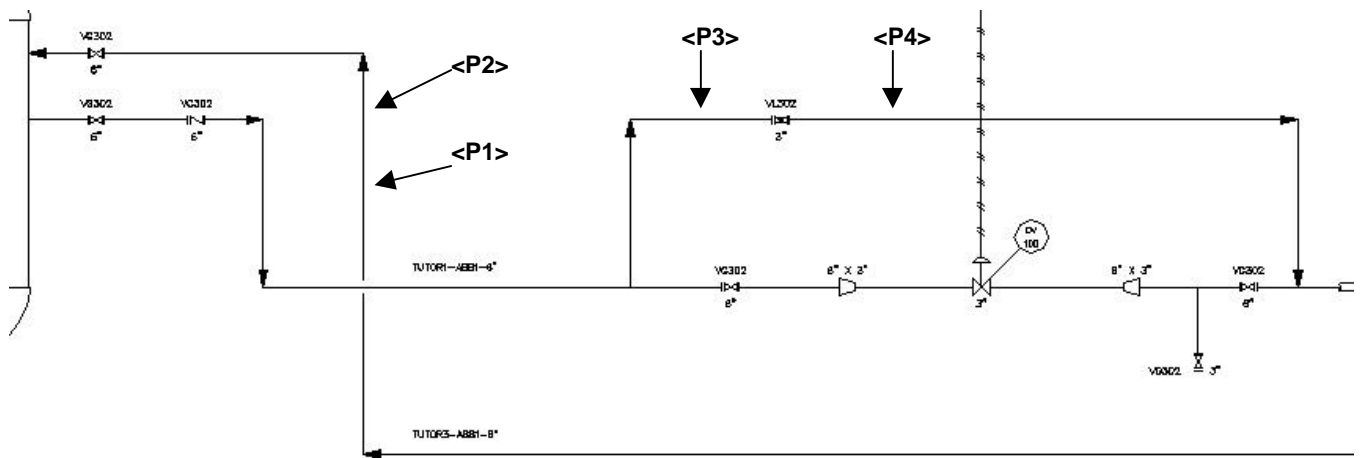

Title Block

Place a title block in the bottom right corner of your drawing.

Command:

Pick "Title Block" from the "ANNOTATION" menu.

(Select the "Default" title block from the pop-up menu. Five title block drawings are supplied.)

Enter insertion point: `_int <P1>` (Use OSNAP INTERsection to pick <P1>.)

Enter Revision Number: `1 <Return>`

Enter Drawing Name: `TUTORIAL <Return>`

Enter Job Number: `10024`

Command:

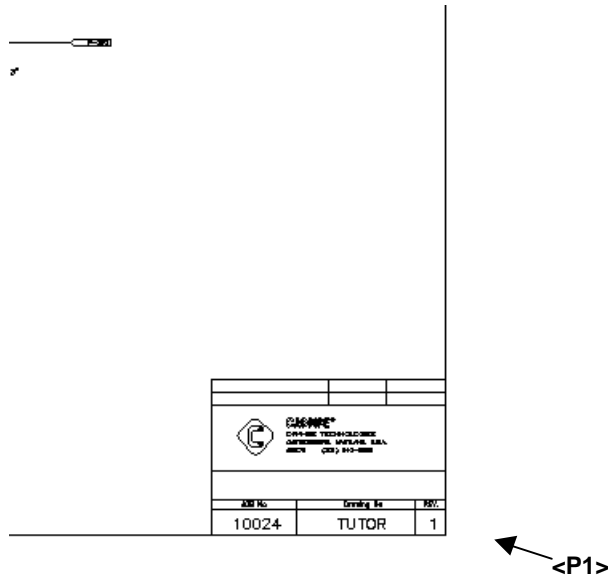

Congratulations, you have completed the CADPIPE P&ID tutorial!

You may want to continue drawing with CADPIPE because there are many more features which have not been demonstrated through this tutorial.

Feel free to experiment, but remember that if you are running the demonstration version of CADPIPE, certain functions will be restricted.