

Contents

MELSEC MEDOC – Start-up guide	1
Start MELSEC MEDOC 32-bit	1
Start MELSEC MEDOC DOS	1
Start options	2
Create a new project, Open a project	3
Programming	3
Transfer to the PLC, Transfer from the PLC	4
Find the I/O, name or step	4
Monitor mode (status display)	5
Monitor mode (status display) in the name list	5
Set/Reset	6
ONLINE-programming (modifying the program in RUN mode)	7
Entry monitor in the instruction list or ladder diagram	8
Entry monitor in the Name Window	9
Copy to floppy disc	10
Copy from floppy disc to the hard drive	10
Function keys	11
Alt-key functions	12
Shortcut keys (hot keys)	12
Troubleshooting	13
MEDOC's connection to the MELSEC PLC system	14



MELSEC MEDOC – Start-up guide

Important!

Read this before you install MELSEC MEDOC:

Copy protection: MELSEC MEDOC is not copy protected. In the licence contract it is described how to copy MELSEC MEDOC.

Licence contract: Enclosed you will find a contract, which is to be filled in and returned to Beijer Electronics.

Uninstallation: Remove all MELSEC MEDOC files from the hard disk by entering (if update version)

C:\>CD MEDOC [↵] - change directory to MELSEC MEDOC

ERASE MEDOC.* [↵] - remove MELSEC MEDOC files

ERASE *.TYP [↵] - remove type files

Installation: Insert the system disk to drive A and type:

A:INSTALL A: C:\MEDOC [↵] (DOS version)

A:SETUP [↵] (32-bit version)

MELSEC MEDOC installs in directory C:\MEDOC.

Start MELSEC MEDOC 32-bit

Start MELSEC MEDOC from the Start-menu,
Start - Programs - MELSEC MEDOC.

Start MELSEC MEDOC DOS

Start by changing to the directory that MELSEC MEDOC is located in.

Example:

C:\>CD MEDOC [↵]

Change to the directory MEDOC

Start MEDOC by entering:

MEDOC [↵]

Start options

The different start options affect the on-screen presentation and activate extended memory management.

Suitable start option for MELSEC MEDOC on PCs running Windows is

MEDOC E3.

Examples of other start options (MEDOC):

MEDOC H2 High resolution mode

MEDOC H3 High resolution mode + compressed ladder diagram

MEDOC E3 Activates extended memory management. Saves the PLC-program on the hard drive.

MEDOC ? Lists all the start options on-screen.

Create a new project

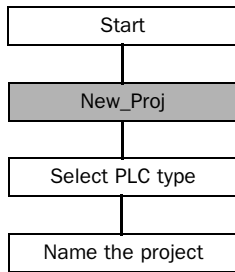

Open a project

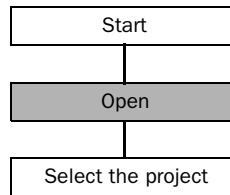

Programming

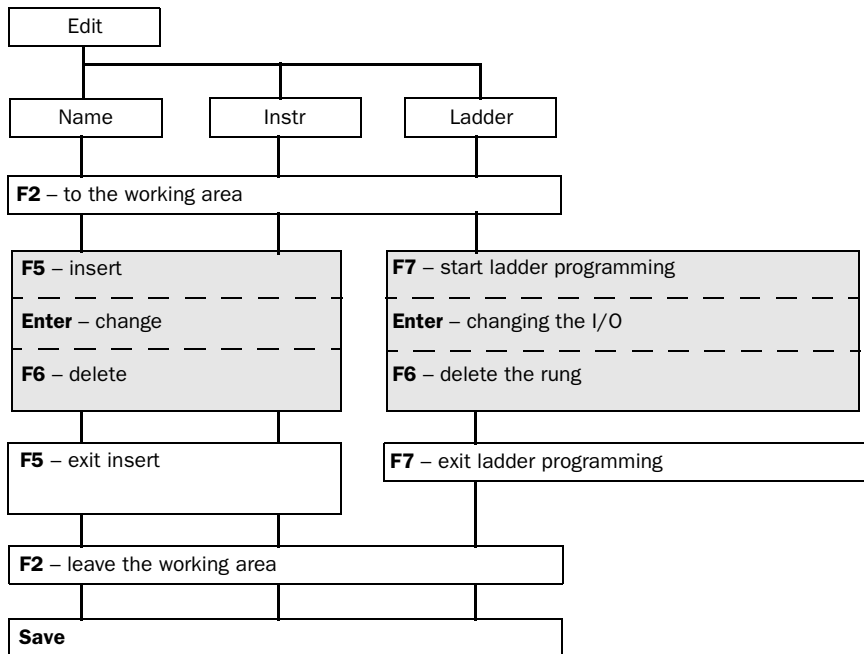

Transfer to the PLC

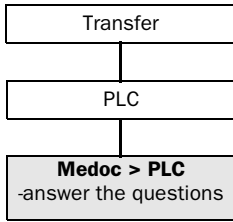

Transfer from the PLC

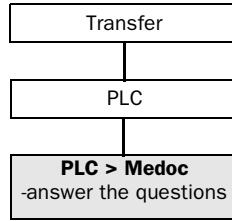

Find the I/O, name or step

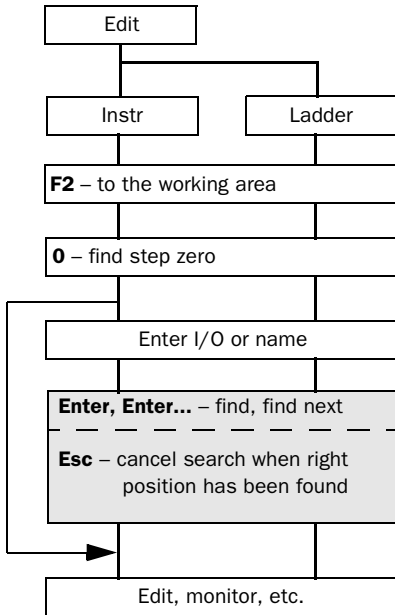

Monitor mode (status display)

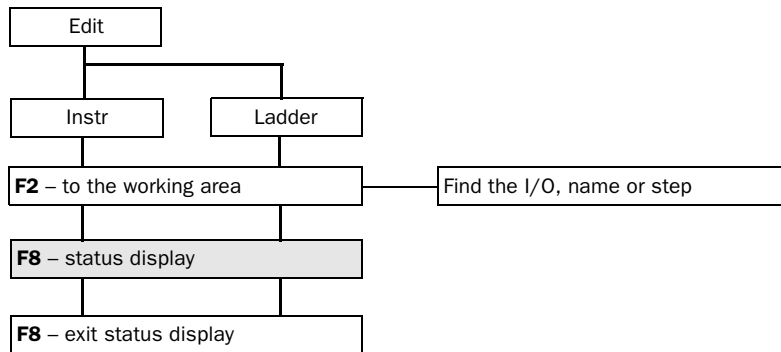

Monitor mode (status display) in the name list

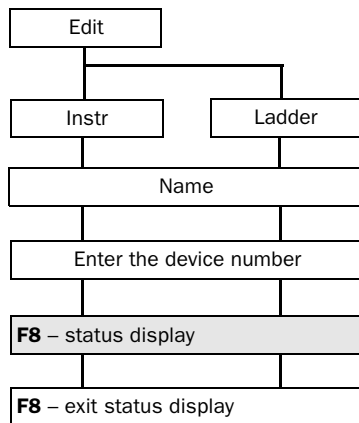

Set/Reset

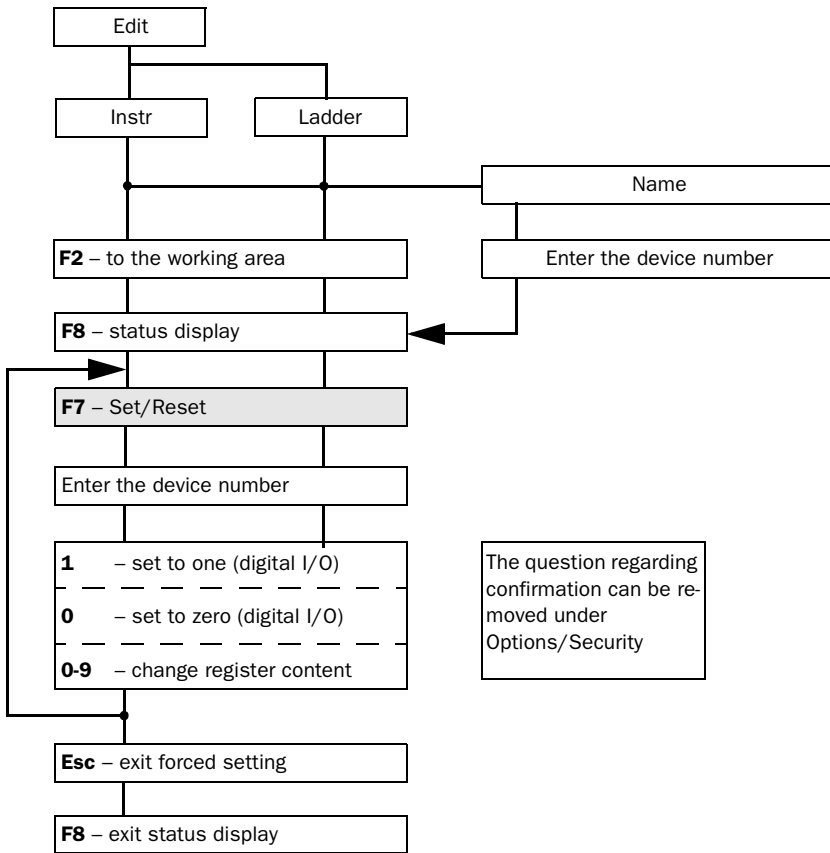

Note!

The PLC-program is superordinate to the forced setting when the PLC is in RUN mode.

ONLINE-programming (modifying the program in RUN mode)

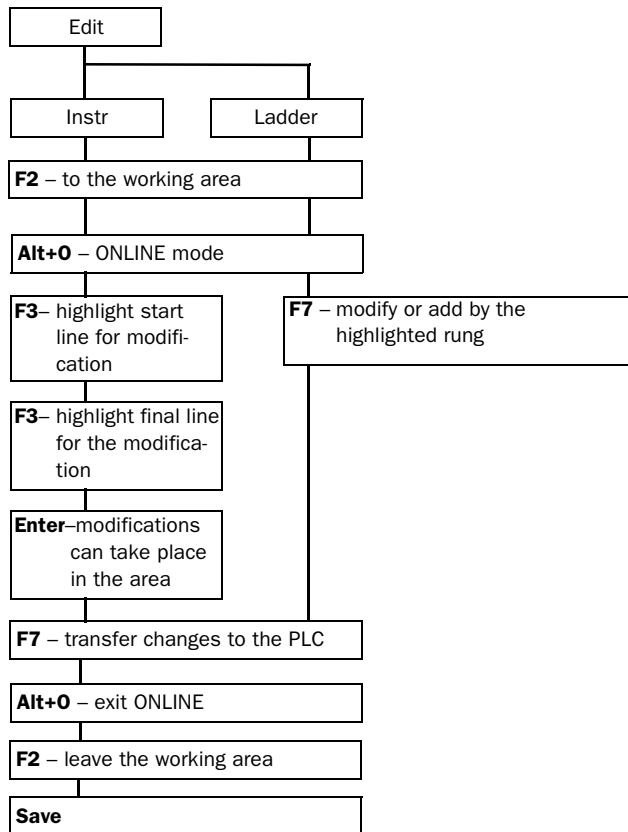

Note!

ONLINE-changes should only be used for minor adjustments such as changing the timer/counter preset or supplementing individual instructions. The program in MEDOC and the PLC must be identical prior to change. The PLC-program may only include **one** END.

Entry monitor in the instruction list or ladder diagram

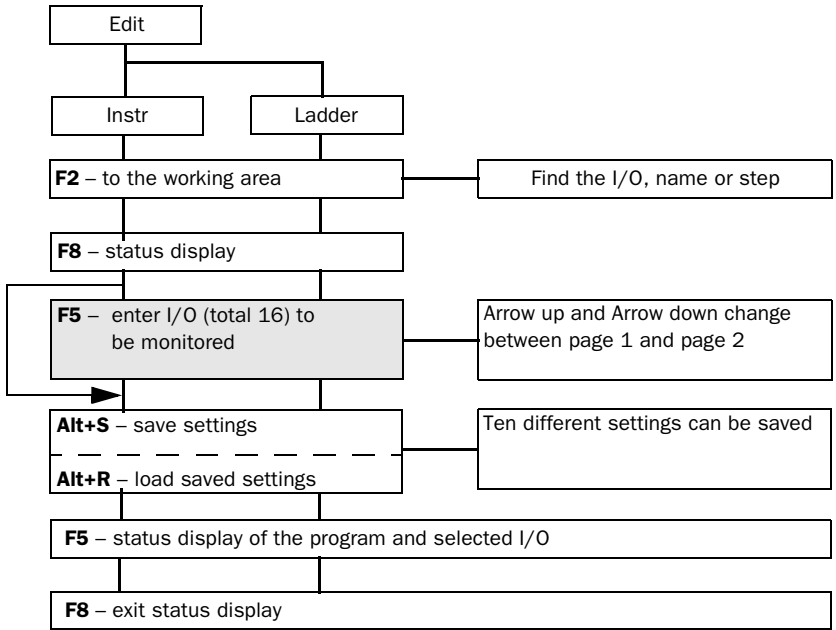

Note!

Saved settings can be retrieved in the Name Window's Entry monitor or in the Device monitor (F9 in the working area).

Entry monitor in the Name Window

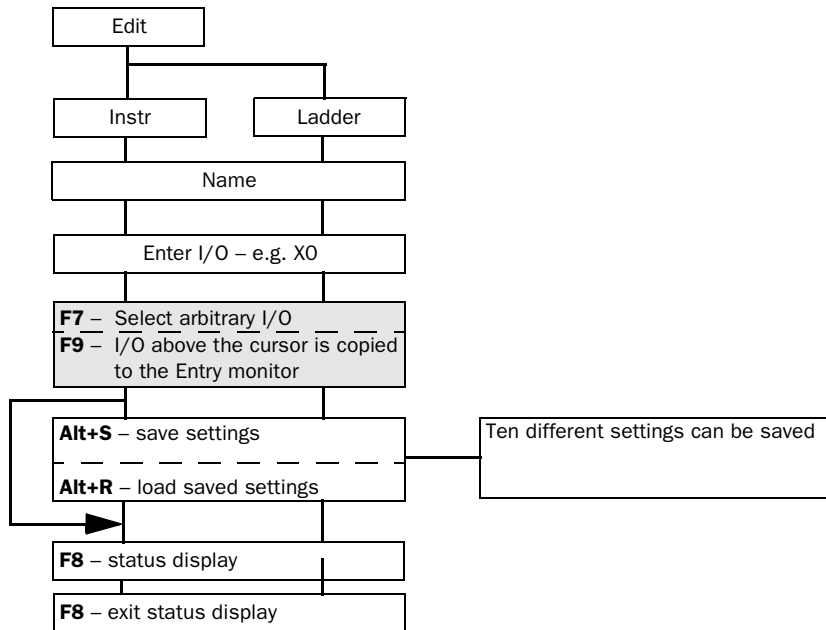

Copy to floppy disc

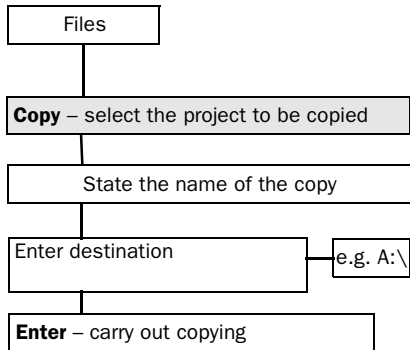

Copy from floppy disc to the hard drive

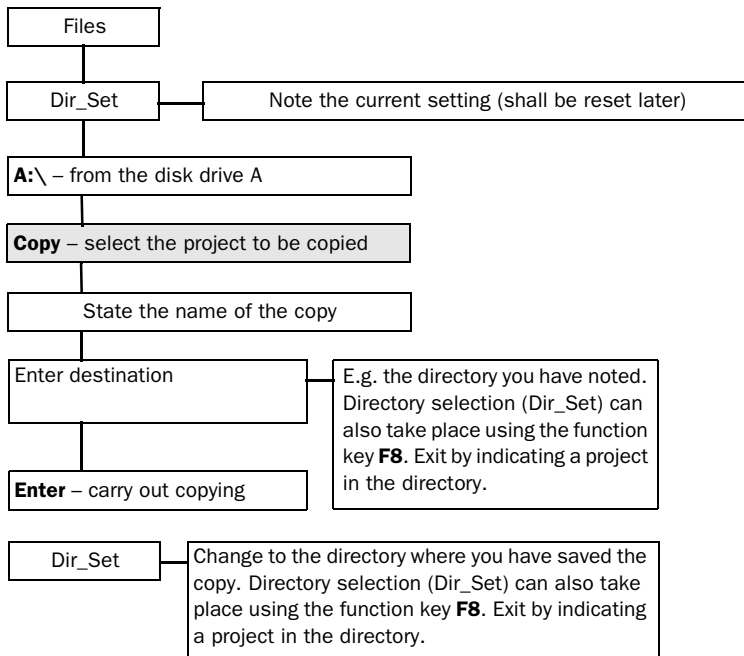

Function keys

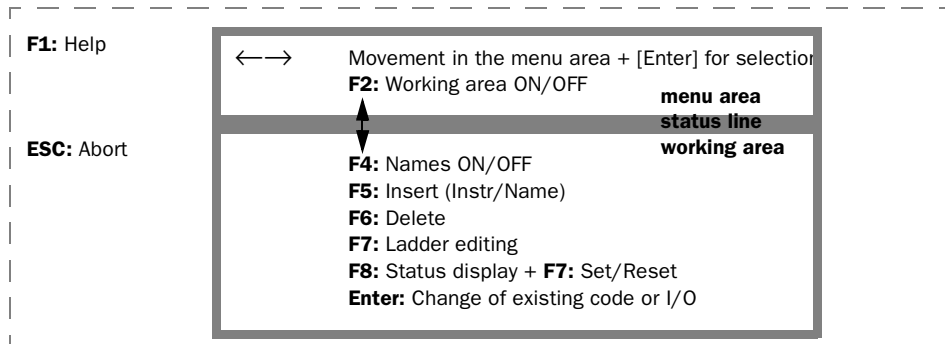

- F1** Help: Show the help text for the current position.
- F2** Jump between the menu area and the working area.
- F3** Marking: Start/stop, used for example when moving an area.
- F4** a) Block name: The block can be selected with “Move”, “Copy” and “Delete”
b) Name: Display of names on/off.
- F5** Insert row.
- F6** Delete line or ladder rung.
- F7** Start/stop programming of ladder rung.
- F8** Monitoring on/off.
- F9** Show further instructions when entering instructions.
- F10** Copy previous row in the name field, special key in other functions.
- Enter** Activation of the selected function.
- Esc** Abort.

Alt-key functions

- Alt+H** Cursor in the working area – High resolution mode on/off
- Alt+O** Edit-Instr/Ladder. Cursor in the working area.
– ONLINE programming mode.
- Alt+C** Edit-Instr/Ladder. Cursor in the working area.
– Line comment reading (programming mode)
- Alt+T** Edit-Ladder. Cursor in the working area.
– Logic check of program from beginning to end and stop with:
1. No error: at the start of the last converted section.
2. With error: at the start of the converted section of the program where the error was discovered.

Shortcut keys (hot keys)

Used to quickly move through the menus.

- 0** Open an existing project (Start Open)
- 1** Edit the instruction list (Edit Instr)
- 2** Edit the ladder diagram (Edit Ladder)
- 3** Edit the name list (Edit Name)
- 4** Edit parameters (Edit Param)
- 5** Transfer between MEDOC and the PLC system (Transfer PLC)
- 6** Transfer between MEDOC and other programming unit (Transfer GPP)
- 7** Printout (Print)
- 8** File management (Files)
- 9** Exit MEDOC (Quit Yes)

Troubleshooting

Reading of Error code when ERROR is lit on the PLC system

1. Start MELSEC MEDOC
2. Open the project
3. Select **Edit**
4. Select **Instr** or **Ladder**
5. Select Name and state the channel number for the error code register
FX-series Error codes: D8060-D8067
Program step: D8069 (if the error is linked to a specific instruction)

A-series Error codes D9008 (AnA/ AnN also have D9091)
Program step D9010 (if the error is linked to a specific instruction)
6. Press **F8** for status display of the register. Read the error code and program step.
7. Exit status display by pressing **F8**.
8. Correct the error.

MEDOC's connection to the MELSEC PLC system

